



Mercedes-Benz

Genuine accessories for the Sprinter

# contents

02 - 03

## cockpit

02	HEATING AND CLIMATE CONTROL
04	COMFORT AND DESIGN
06	SEAT COVERS AND MATS
08	INFOTAINMENT
12	COMMUNICATION

## contour

14	FRONT
16	MANOEUVRING AND TOWING
18	LIGHT-ALLOY WHEELS

## cargo

20	ROOF RACK SYSTEMS
22	LOAD COMPARTMENT AND TRANSPORTATION

**True quality reveals itself in day-to-day practice** and here the Sprinter, in all its equipment variants, clearly sets standards. But it's not just size and optimum loading conditions that count - passenger-friendly comfort, safety and cost-effectiveness are also key if you want to meet the demands of today's working environment.

Over the following pages we will show you how you can make your mobile workplace even more individual. Whether it's effective additions to the transportation concept, highly flexible roof-mounted solutions or high-tech navigation, communication and infotainment systems - when it comes to variety, our genuine accessories for the Sprinter raise the bar a little higher.



### **Air conditioning system**

Select your temperature, at the touch of a button, and the sensor-controlled air conditioning system will maintain it - both in summer and in winter. The system also has a dehumidifying effect, which helps keep the windows clear. And with its integrated air filter, it also protects against dust and pollen. The air conditioning system should be fitted by a specialist workshop, for example your Mercedes-Benz service outlet.

Order no. B6 656 0770



**Parameterisable special module  
for individual attachments**

The PSM control unit forms the interface between the vehicle's electronic systems and those of the attachment manufacturer. The special module allows specific functions to be implemented and added (e.g. working speed control). 10 inputs and 20 outputs are available.

Order no. B6 656 0734



### Cockpit trim

In perfect trim: two alternative trim packages are available for the cockpit highlights and the centre console trim panel. These trim components blend smoothly with the overall cockpit styling and lend the interior an individual feel. Both versions - the silver 3D paint finish [1] and black walnut [2] - are made of high-grade plastic. They are also easy to fit: simply take out the standard trim parts and swap them for the accessories.

Order no. - see price list



### Coolbox

Even on really long days or long journeys the coolbox, made of hygienic, easy-to-clean plastic, provides constant and dependable cooling performance - thanks to the on-board 12-volt power supply. The box can be firmly secured in the load compartment with the aid of the special strap system. It's also easy to carry, using the handy carry straps. The coolbox has a capacity of 16 litres.

Order no. B6 656 0300



**Writing surface**

This practical writing surface simply hooks over the steering wheel. It comes with handy clips for holding your papers.

Order no. B6 656 0388



**Coat hanger**

Keeps shirts and jackets, for example, looking immaculate. Simply fits onto head restraint.

Order no. B6 656 0416



**Litter bag**

Dispose of litter easily and elegantly in this 5-litre vinyl bag. The hygienic liner bags are easily removed. Take out one bag and the next bag moves into position automatically.

Order no. B6 656 0320



**Stowage box in twin co-driver's seat**

The stowage box, made of impact-resistant plastic, fits flush into the seat base frame and provides generous stowage space and organisation in the left-hand part of the seat base. A divider is supplied and you can also insert tabs. The stowage box prevents damage to the inside of the seat base and prevents small items from getting lost. The stowage box is simple to install - just drop it into place in the seat base. The flush-fitting design means that the stowage box is self-securing.

Order no. B6 656 0921



**Office bag**

This elegant vinyl briefcase-cum-laptop bag converts into a portable office in moments. The office bag can be strapped around the backrest using the integrated belt, while a further belt wraps round the neck rest, allowing the bag to remain open while driving. This way you can keep everything from your mobile phone to an A4 writing block conveniently close to hand.

Order no. B6 656 0417



**Cruise control**

Cruise control makes the driver's job easier, especially when it comes to obeying speed limits, but also when driving long distances or towing a trailer. The selected speed is stored and maintained - although manual intervention is of course possible at any time.

Order no. B6 656 0975

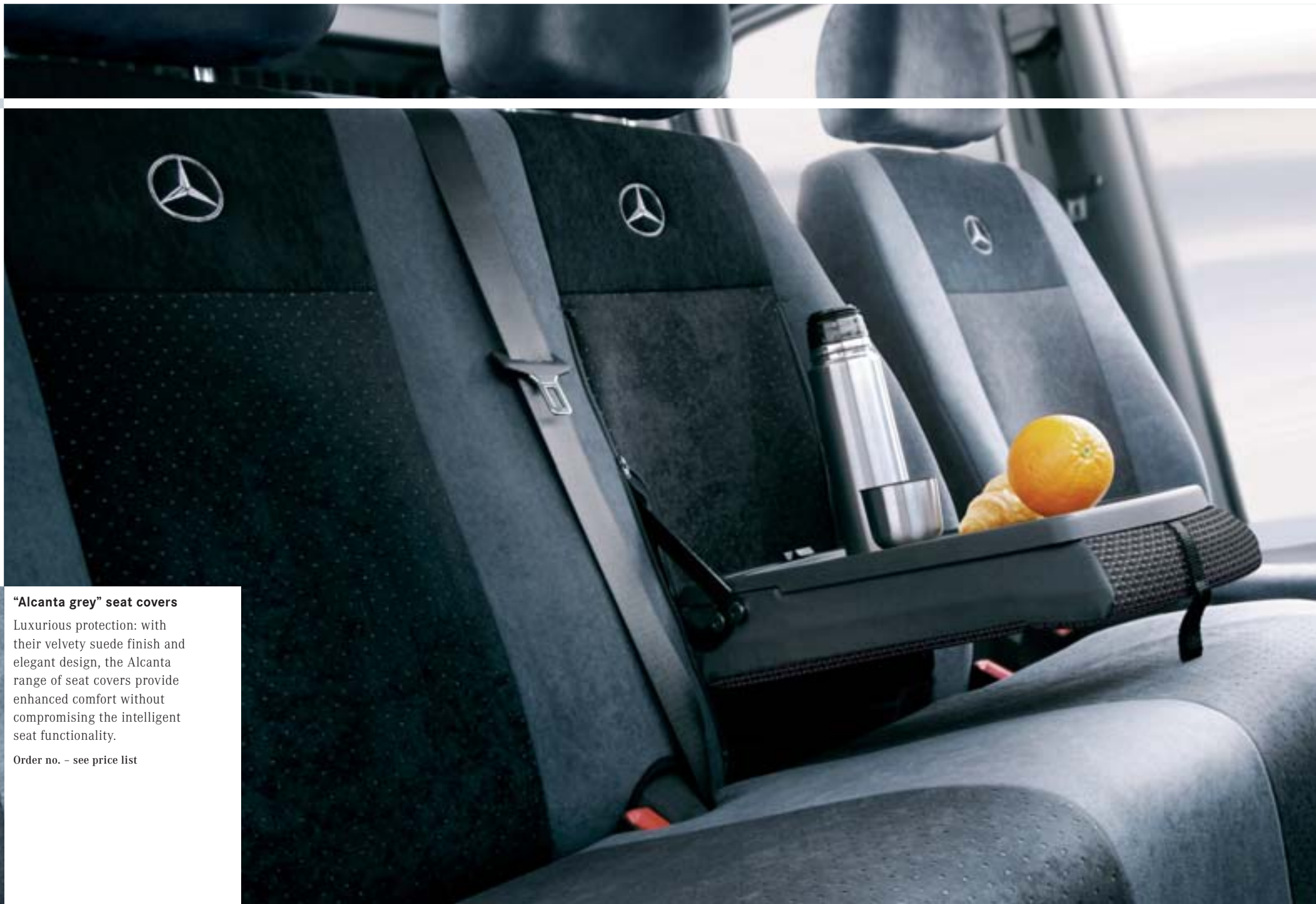

**“Alcantara grey” seat covers**

Luxurious protection: with their velvety suede finish and elegant design, the Alcantara range of seat covers provide enhanced comfort without compromising the intelligent seat functionality.

Order no. - see price list



**1 | “Brasao black” seat covers**

**2 | “Lima black” seat covers**

Superb fit, regular design: the colour and design of these seat covers are modelled on those of the original seats. They are available for almost all seat versions. At the same time, special functions like the integral table on the twin co-driver’s seat, and the ISOFIX attachment system, are retained in full.

Order no. – see price list



**Protective covers**

Just in case: the robust oil and dirt-repellent protective covers are easy to fit and can be used either as a temporary measure, when visiting the workshop, or permanently, for example on the construction site.

Order no. – see price list

**Rubber floor mats**

Amazing attention to detail: the rubber floor mats, made of robust, dirt-repellent natural rubber, fit flush with the interior of the vehicle. Zip fasteners securely connect adjacent sections of mat. This provides extensive floor coverage with no intervening gaps, and prevents the mats from sliding around. At the same time the mats can also be easily removed for cleaning.

Order no. – see price list



**3 | Velour floor mats**

The soft velour floor mats, with their Sprinter lettering and their custom fit to prevent sliding, create an elegant impression on entering the vehicle. Extensive coverage of the footwell creates a comfortable, cosy feel.

Order no. – see price list

**4 | Rep floor mats**

The precision-fit, hard-wearing, easy-to-clean rep floor mats are fitted with a sewn-in Velcro fastener that prevents them from sliding around the floor. The exclusive Sprinter lettering greets you every time you step on board.

Order no. – see price list



*Child safety products are available as part of the Mercedes-Benz Child Safety range. For more information, please consult your Mercedes-Benz service outlet.*

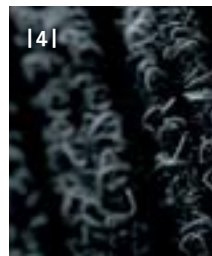
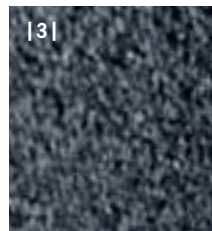

## COMAND APS

Our innovative multimedia system combines contemporary in-car hi-fi technology with an intelligent hard-drive-based navigation system (for navigation throughout Europe): the 6.5" TFT colour display with high-resolution map depiction and dynamic route guidance (takes into account congestion information provided via TMC) ensure optimum driver information. Up to 4 GB of memory offers space for your favourite music in MP3 format. And of course COMAND APS also plays audio or video DVDs. COMAND APS can be operated via the multifunction steering wheel. Available with DVD changer as an option.

Order no. – see price list

1 | Navigation DVD for Sound 50 APS

2 | Navigation DVD for COMAND APS

**Rediscover navigation.** In recent years integral navigation has made journeys more relaxed, less time-consuming and, above all, safer. If you want to continue to enjoy these advantages to the full, we recommend that you regularly replace the navigation DVD in your navigation system with the latest version. Ensuring that the data you're using matches the roads you're travelling on. And that the only surprises you encounter during your journey are of a pleasant nature. Please ask your Mercedes-Benz partner for the latest map versions.



| 1 |

| 2 |





**Sound 50 APS**

The Sound 50 APS offers DVD navigation throughout Europe, with convenient arrow-based instructions on the 5" TFT colour display. Dynamic route guidance via TMC is as integral to the system as the three radio tuners, the MP3-compatible DVD player and the Bluetooth interface with standard hands-free function. Sound 50 APS allows you to input numbers using the telephone keypad or can be operated using the multifunction steering wheel. Available with DVD changer as an option.

Order no. - see price list



**Sound 20**

All inclusive: compact twin-tuner radio with MP3-compatible CD player and Bluetooth interface with hands-free function. Sound 20 can be operated using the telephone keypad or the multifunction steering wheel. Available with DVD changer as an option.

Order no. - see price list



**Sound 5 radio**

CD radio (can be operated via multifunction steering wheel) with 25 station presets and connection for MP3 CD changer or MP3 player. The Sound 5 comes with ID3 track display for the CD changer.

Order no. B6 656 0866



**Sound ONE**

Exclusive sound: with 4 x 45 W output for radio, CD or MP3 (can be controlled via the multifunction steering wheel). The detachable anti-theft front panel incorporates an AUX port for your MP3 player. Variable button illumination colour.

Order no. B6 656 0722



**MP3 CD changer**

The (six-disc) MP3 CD changer is ID3-compatible, can read CD-R/RW and can be controlled via the multifunction steering wheel. Only in conjunction with Sound 5 and Sound ONE.

Order no. B6 656 0580

### Tachograph

This type of tachograph is mandatory under EU law for vehicles that are registered as commercial vehicles and whose gross weight exceeds 3.5 t, and also for vehicles carrying 9 passengers (plus driver) or more. It provides tamper-proof recording of speeds and rest times. The data is rapidly and easily acquired and can be electronically evaluated. Outside the EU, the modular tachograph can be used.

*Digital tachograph*

Order no. B6 656 0870/71

*Modular tachograph*

Order no. B6 656 0874

*Wiring*

Order no. B6 656 0872/73



### iPod/iPhone holder

Black plastic holder, designed to secure your iPod in place in the glove compartment. The soft, flocked surface protects your digital music player from scratches and prevents it from sliding around. For the iPod Interface Kit.

Order no. B6 782 4501

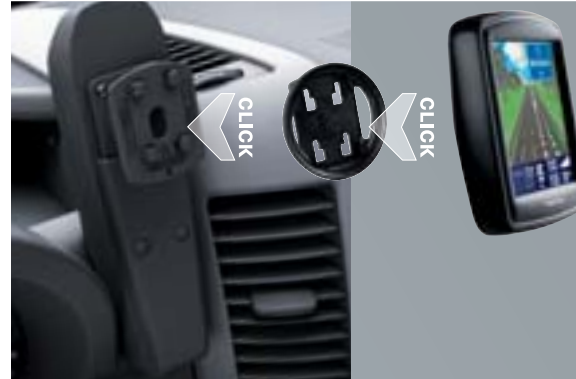

**Adapter for TomTom ONE navigation unit**

If your vehicle is fitted with special equipment Code EV9, pre-installation for portable devices, you will be able to secure your TomTom ONE navigation unit in place on board. To connect your portable navigation unit, you will need this device-specific adapter in addition to the pre-installation.

Order no. – see price list

*Picture shows similar product. Navigation unit not included.  
For details, please contact your Mercedes-Benz partner*



<sup>1</sup> The Mercedes-Benz Interface Kit allows you to listen to music via the iPod application on your iPhone. It does not support the phone function

*For details and a list of supported devices, please contact any Mercedes-Benz service outlet*



*Flexible entertainment: the swivelling reversing camera monitor can also be connected to a portable DVD player. How about a film? More on page 16.*



**Mercedes-Benz iPod® Interface Kit<sup>1</sup>**

It's easy to control your iPod via the multifunction steering wheel: scroll through the menus [A], adjust the playback and volume [B] and display the track of your choice in the instrument cluster [C]. The iPod is connected in the glove compartment where it is hidden from prying eyes. Its battery is also charged while connected.

Order no. B6 782 4559



111

#### Mobile-phone holders

When it comes to selecting a mobile phone for your Mercedes-Benz Sprinter, you've never had so much choice. One "click" is all it takes to replace the mobile-phone holder. It takes a matter of seconds and is as straightforward as inserting the mobile into the holder itself.

Even when used with the **non-networked hands-free system**<sup>2</sup> the holders offer numerous advantages: the battery charging function for your mobile and optimum visibility are key features of the system. Optimum reception quality is ensured by using the vehicle's external aerial.

If your vehicle is fitted with a **networked hands-free system**<sup>3</sup>, the holders offer you even more: here you can operate your mobile phone using the multi-function steering wheel for added convenience and have access to the phone's internal memory.

Order no. - see price list

**1 | Hands-free system<sup>2</sup> (non-networked)**

For all drivers who wish to operate the mobile phone with the Sound ONE or Sound 5 radios or the radio pre-installation, the universal system offers optimum visibility and is simple to install.

Order no. – see price list

**2 | Hands-free system<sup>3</sup> (networked)**

Communication and convenience: the networked hands-free system, which is easy to operate using the multifunction steering wheel and the central display in the instrument cluster.

Order no. – see price list

*To retrofit a hands-free system, you need the mobile phone retrofit kit, a mobile-phone console and the right mobile-phone holder for your phone.*

*Mobile-phone holders are available for many popular models sold by Nokia, Sony Ericsson, BlackBerry, Apple and Motorola. The range of holders is constantly updated. Please contact your Mercedes-Benz partner for details.*



<sup>2</sup> Code ET5

<sup>3</sup> Code EH4

<sup>4</sup> SAP (SIM Access Profile) allows the mobile phone's SIM card to be read. Only in conjunction with networked hands-free system (Code EH4)

<sup>5</sup> Only in conjunction with non-networked hands-free system (Code ET5)

**Mercedes-Benz Bluetooth® telephone modules**

With the Mercedes-Benz telephone module you can use the phone via your on-board hands-free system, so there is no need to physically connect your mobile on board. You no longer have to move your mobile between the holder and your jacket pocket, so there is less chance of accidentally leaving it behind in the vehicle.

**3 | Bluetooth (SAP) telephone module<sup>4</sup>**

Making phone calls, looking for a number, checking call lists, receiving and reading text messages – all can be conveniently controlled using the multifunction steering wheel, the audio system, the central display and the instrument cluster. The SAP box features an integral USB port which allows you to charge your mobile.

Order no. – see price list

**4 | Convenience control module<sup>5</sup>**

The convenience control module allows you to use your phone via Bluetooth and offers access to the phone's internal memory. Thanks to the display, the phone is controlled from the telephone module itself.

Order no. – see price list





11

12

13

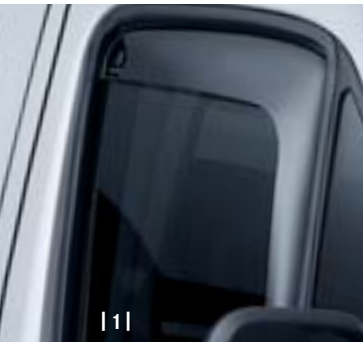

| 1 |



| 2 |

### 1 | Side window wind deflector

When the window is ajar, the custom-fit wind deflector prevents dust, moisture and even insects from entering the vehicle, and prevents fogging of the windows. Its draught-inhibiting function brings further comfort benefits.

Order no. B6 656 0104

### 2 | Exterior sun visor

A glaring improvement: the exterior sun visor prevents dazzle even when the sun is low in the sky - but without restricting the driver's field of view. It also emphasises the Sprinter's sporty front-end appearance.

Order no. B6 656 0920

### 3 | Chrome highlights for radiator grille

Brightly embellished: the bright chrome radiator grille highlights add further appeal.

Order no. B6 656 0948



### Roof-mounted wind deflector

Looks and functionality at their best: the roof-mounted wind deflector is optimally tailored to box bodies and tarpaulin bodies. Its aerodynamic form minimises wind noise in the passenger compartment and can help achieve a fuel reduction of up to 2.5 l/100 km. It also offers an excellent advertising space, ideal for example for your company name.

Order no. - see price list

### Spare bulb box

Space-saving and close to hand: the spare bulb box contains a full set of standard bulbs.

Order no. B6 656 0805



### "Black Line" tail light

A sporty finish: enhance the appearance of your Sprinter by accentuating the rear end with "Black Line" darkened tail light units.

*Left tail light unit*

Order no. B6 656 1007

*Right tail light unit*

Order no. B6 656 1008

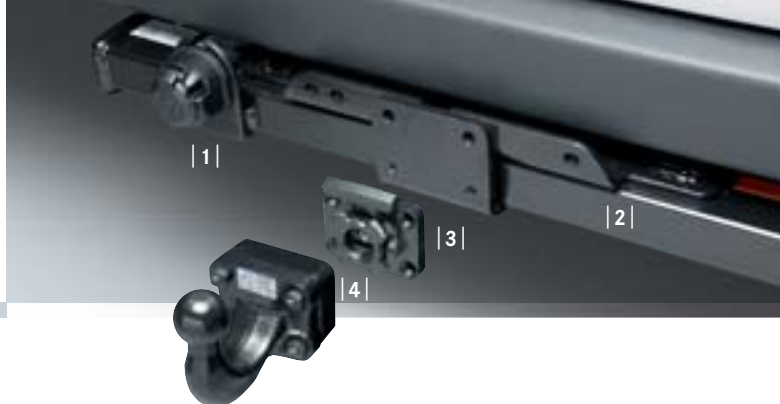

### Trailer coupling

Our range of trailer couplings allows you to choose between various system versions and components to suit your individual requirements. Maximum towing capacities range from 2.0 to 3.5 t, with maximum drawbar loads of up to 140 kg.

#### 1 | Trailer wiring kits

Lighting and signalling systems for your trailer.

Order no. - see price list

#### 2 | Cross-member

Basis for fitting fixed and detachable (Variobloc) ball-head or jaw-type trailer couplings.

Order no. - see price list

#### 3 | Variobloc detachable trailer coupling system

Robust and flexible: with Variobloc, swapping between different trailer couplings is never a problem.

Order no. B6 684 8912

#### 4 | Detachable ball head for Variobloc system

Order no. B6 656 0895

#### 5 | Detachable jaw coupling for Variobloc system

Order no. B6 684 8916



#### Ball-type trailer coupling (complete system)

The complete system has the ball head already welded to the cross-member. (not pictured)

Order no. - see price list

#### Ball head for trailer coupling (fixed)

The ball head bolts on to the cross-member. (not pictured)

Order no. B6 656 0896

#### Jaw for trailer coupling (fixed)

The jaw bolts on to the cross-member. Can be swapped for the fixed ball head. (not pictured)

Order no. B6 684 8916



#### Monitor for reversing camera

Multifunctional: the tilt-and-swivel reversing camera monitor is optimally adjustable. The 7" TFT monitor is automatically activated when the vehicle goes into reverse. The display and volume can be intuitively controlled using the buttons on the front side of the unit. During rest breaks, the monitor can be connected to a portable DVD player. The monitor is pre-fitted in the stowage tray and can be quickly and easily extended and retracted.

Order no. - see price list

#### Wiring for reversing camera

If you don't have pre-installation for the reversing camera, then not to worry. With the special installation kit, you still don't need to miss out on this system. (not pictured)

Order no. - see price list



#### Ultrasonic reversing aid

The reversing aid assists the driver when reversing by ultrasonically detecting obstacles up to a distance of 1.60 metres behind the vehicle. Audible signals aid safe manoeuvring and parking.

Order no. B6 656 0666

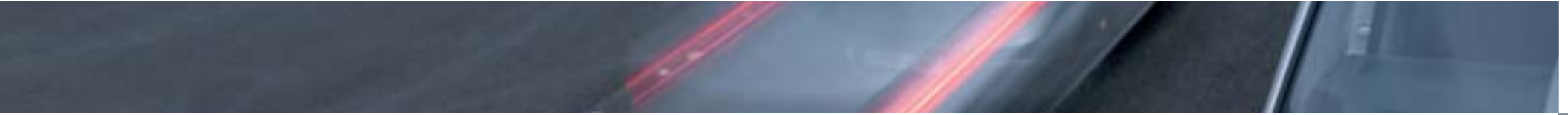

#### Reversing camera

Systematically coordinated innovation: the reversing camera assists the driver right from the start of the reversing manoeuvre. The camera is activated automatically, as soon as reverse gear is engaged. There's also a built-in microphone, so you can not only see but hear what's going on behind the vehicle. The camera image is conveniently displayed either on the COMAND display or on the reversing camera monitor.

Order no. – see price list





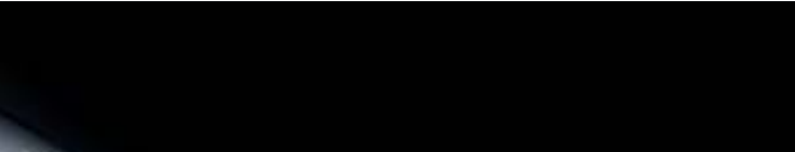

**17" light-alloy wheel**

Sparkling design: seven-twin-spoke wheel in high-quality aluminium, painted brilliant silver.

Wheel size: 6.5 J x 17 ET 62 | Tyre size: 235/60R 17C

Order no. B6 656 0390



**Hub cap with chrome star**

The hub cap protects the wheel hub against dirt and is also elegantly eye-catching.

Order no. B6 647 0202

**16" light-alloy wheel**

High-quality aluminium six-spoke wheel, painted brilliant silver.

Wheel size: 6.5 J x 16 ET 62 | Tyre size: 235/65R 16C

Order no. B6 656 0389

**Full wheel trim**

Brilliant silver finish: the 16" plastic full wheel trim fills two needs at once - it protects the wheel against dirt and at the same time enhances the appearance of your Sprinter.

Order no. B6 656 0733



**Quick-fit snow chains**

Exclusive to the Sprinter: the snow chains, in high-strength chrome manganese micrograin stainless steel with reinforced chain links, provide excellent grip on snow and ice. Needless to say they are also quick and easy to fit.

Order no. - see price list

**Mud flaps**

Made of long-life plastic, the mud flaps meet the highest standards of quality and functionality. They help to protect the body against dirt and scratching and at the same time improve visibility for following vehicles.

Order no. - see price list



**Rim locks**

Can only be unlocked with the coded key. One rim lock per light-alloy wheel provides simple yet effective protection.

Order no. B6 601 0040

**Wheel bolts**

Secure your light-alloy wheels.

Order no. B6 656 0677





**Ladder rack**

A wide variety of ladders can be safely transported on the basic carrier bars using the ladder rack.

Order no. B6 656 0807



**1 | Cargo rack**

Flexible load transportation: the cargo rack can be used to transport many different types of cargo and can be adapted to any length of vehicle (panel van or crewbus). The accessories sales consultant at your Mercedes-Benz service outlet will be pleased to help you configure the right components for your vehicle.

Order no. – see price list

**2 | Loading roller**

The hard-rubber loading roller allows you to slide even unwieldy items onto the carrier bars or roof rack with ease. And without causing scratching.

Order no. B6 656 0816

**C-rails**

Basis for roof transport: the C-rails provide the basis for fitting carrier bars and roof racks. They offer maximum roof loads of 150 kg for high-roof versions (LH2) and 300 kg for standard-roof versions (LH1).

Order no. – see price list



**Basic carrier bars**

The robust basic carrier bars can be mounted in any position on the C-rails. The strong, 30 x 30 mm steel bars always provide a level loading surface, and their plastic sheathing protects both the bars and the cargo. The maximum roof load per crossbar is 50 kg (including bar). NB: observe overall maximum roof load.

*Crossbar including 2 supports*

Order no. B6 656 0800

*3 crossbars including 6 supports*

Order no. B6 656 0801



**High-standing bracket set**

A quick and easy way of preventing all types of cargo mounted on the basic carrier bars from shifting sideways.

Order no. B6 656 0806



**Ladder with transport securing system**

Always at hand: a patented, innovative addition to your cargo equipment. The light-alloy ladder simply pulls out from the guide rails and can then be tilted down ready for use. The ladder facilitates safe loading and unloading of carrier bars and cargo racks under all circumstances. Of course, the ladder can also be attached elsewhere. On the vehicle flanks, for example. Here, a securing kit prevents the ladder from becoming unseated. After use, the ladder simply slides back into place and can be securely locked. Best of all, this does not restrict the load area in the slightest.

Order no. B6 656 0777

*Securing kit for ladder if basic carrier bars are fitted*

Order no. B6 656 0778

*Securing kit for ladder if cargo rack is fitted*

Order no. B6 656 0779

*The accessories sales consultant at your Mercedes-Benz service outlet will be pleased to help you configure the right components for your vehicle.*





| 1 |



| 2 |

### Load-securing straps and rings

The cargo strap system, which attaches easily to the prefitted load-securing rails, provides an unbeatable and simple way of securing your cargo.

**1** | *Ratchet strap with two double-stud rings*

Order no. B6 656 0748

**2** | *Two quadruple studs for floor rails, straps not included*

Order no. B6 656 0817

**not pictured** | *Four double-stud rings, straps not included*

Order no. B6 656 0749



### Non-slip mats

Slip-resistant transport: the flush-fitting, modular mat set is an effective way of protecting the wood floor in the load compartment from dirt and damage. The load-securing rings in the load compartment remain fully accessible. The mats are secured to the floor in the door area by mouldings. The mat set, which is made of foam-backed vulcanite, also has vibration and sound-damping properties. It is easy to lay.

Order no. - see price list



### Stowage box for pickup

Extra capacity and extra protection: whether it be tools or personal items, the securely attachable stowage box (capacity 30l) shields its contents from water spray. One shockproof plastic box can easily be mounted on each side of the pickup.

Order no. B6 656 0859



### Multipurpose box

Big things come in small packages. This practical folding box is ideal for shopping and a host of other transportation tasks; it can be folded flat, is waterproof and can carry up to 30 kg in weight. When the box is folded flat, it doubles as a protective mat.

Order no. B6 656 0323



### Load-securing net

Load restraint made easy: the net is stowed in the roof, ready for use any time by means of a lift system. After loading, it can be spread over the cargo quickly, easily and without any tangles, then firmly attached to the load compartment floor by means of tensioning straps. Moreover, this can be done conveniently from the side or rear door, thanks to an intelligently designed cable system. The package includes the net, lift system, straps and fasteners.

*Load-securing net for standard body length*

Order no. B6 656 1041

*Load-securing net for long body length*

Order no. B6 656 1042

*Load-securing net for extra-long body length*

Order no. B6 656 1043



### Fluorescent jacket

Already compulsory in many countries, the bright orange and yellow fluorescent jackets with reflective stripes are conspicuous even in the dark.

*Single*

Order no. A000 583 0461

*Pack of two*

Order no. A000 583 0361



### Charger with trickle charge function

With its cutting-edge technology, the Mercedes-Benz charger ensures the longest possible battery life. Available in a 3.6 amp version (below) and a 25 amp version (not pictured).

*Charger 3.6A*

Order no. B6 754 2028

*Charger 25A*

Order no. B6 754 2027

Please note: changes may have been made to the products since this brochure went to press (30.07.2009).The manufacturer reserves the right to make changes to the design, form, colour and specification during the delivery period, provided these changes, while taking into account the interests of the vendor, can be deemed reasonable with respect to the purchaser. Where the vendor or the manufacturer uses symbols or numbers to describe an order or the subject of an order, no rights may be derived solely from these. The illustrations may show accessories and items of optional equipment which are not part of standard specification. Colours may differ slightly from those shown in the brochure, owing to the limitations of the printing process. This brochure has been compiled by Daimler AG of Germany and is distributed internationally. It provides a general indication of the range of models, features, optional extras and/or colours available in various countries. Some of the models, features, optional extras and/or colours may not be available in your country or may only be available in a different specification. Additionally some models, features, optional extras and/or colours may only be available in combination with others. For current and more specific information in relation to the range of models, features, optional extras and/or colours available in your country, and their pricing, you should contact your nearest authorised Mercedes-Benz Dealer.